

SPECIFICATIONS

FOR TOPLITE COB MODULE

MODEL: ATE-R10



TOPLITE INTERNATIONAL LLC.

www.topliteusa.com



TECHNICAL DATA SHEET

ATE-R10 <FOR TOPLITE COB MODULE>

1. PRODUCT APPEARANCE

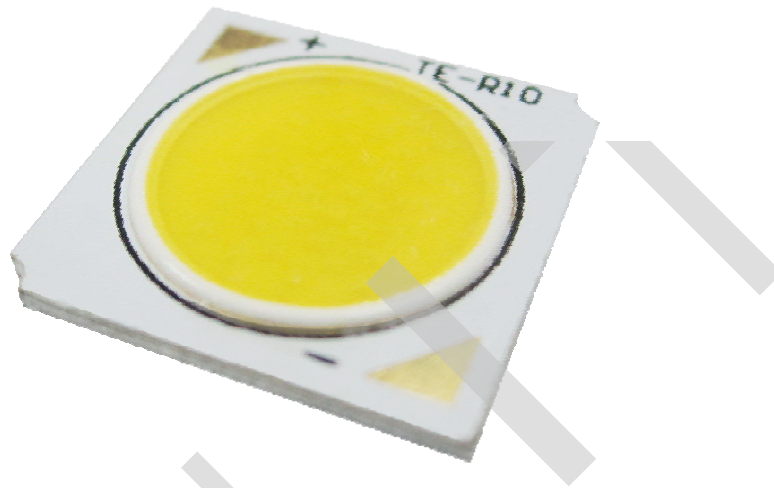

2. OUTLINE DRAWING

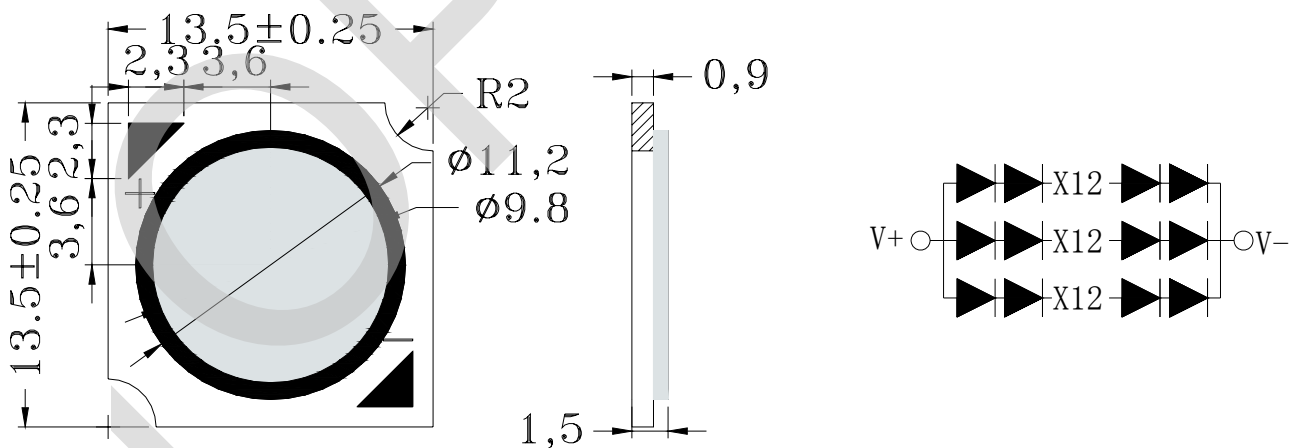

Unit: mm

Tolerance: ± 0.25

**TECHNICAL DATA SHEET****ATE-R10** <FOR TOPLITE COB MODULE>**3. PERFORMANCE PARAMETERS****3-1. ABSOLUTE MAXIMUM RATINGS**

ITEM	SYMBOL	RATING	UNIT
Power Dissipation	P	11.7	W
Forward Current	I _F	360	mA
Reverse Voltage	V _R	60	V
Operating Temperature	T _{opr}	- 30 ~ + 80	°C
Storage Temperature	T _{stg}	- 40 ~ + 100	°C
Junction Temperature	T _{jmax}	110	°C

Note:

*1. Forward Current allows maximum surge current ≤ 10 ms.

*2. Power dissipation and forward current are the values when the LED is used within the range of the derating curve in this data sheet.



TECHNICAL DATA SHEET

ATE-R10 <FOR TOPLITE COB MODULE>

3-2. ELECTRICAL-OPTICAL CHARACTERISTICS

(T_c=25°C)

**	PARAMETER	SYMBOL	CONDITION	MIN.	TYP.	MAX.	UNIT	
common	Forward Voltage ^{*1}	V _F	I _F =180mA	33.6	36	39.6	V	
	Beam Angle	Deg		—	120	—	Deg	
W	** Color Temp.	T _C	I _F =180mA	2870	3045	3220	K	
	** Color Rendering Index ^{*3}	R _a		80	—	—	—	
	W ₁	Luminous Flux ^{*2}		Φ	590	615	—	lm
		Luminous Efficiency		η	91	95	—	lm/W
	W ₂	Luminous Flux ^{*2}		Φ	622	648	—	lm
		Luminous Efficiency		η	96	100	—	lm/W
D	** Color Temp.	T _C	I _F =180mA	4745	5028	5311	K	
	** Color Rendering Index ^{*3}	R _a		80	—	—	—	
	D ₁	Luminous Flux ^{*2}		Φ	648	680	—	lm
		Luminous Efficiency		η	100	105	—	lm/W
	D ₂	Luminous Flux ^{*2}		Φ	687	712	—	lm
		Luminous Efficiency		η	106	110	—	lm/W
C	** Color Temp.	T _C	I _F =180mA	6020	6530	7040	K	
	** Color Rendering Index ^{*3}	R _a		80	—	—	—	
	C ₁	Luminous Flux ^{*2}		Φ	680	712	—	lm
		Luminous Efficiency		η	105	110	—	lm/W
	C ₂	Luminous Flux ^{*2}		Φ	720	745	—	lm
		Luminous Efficiency		η	101	115	—	lm/W

(Note) Parameters is formulated based on shipping samples

*1. After 20 ms drive, Measurement tolerance: ± 3 %

*2. Monitored by Toplight's 1 m integrating sphere, after 20 ms drive, Measurement tolerance: ± 10 %

*3. Monitored by Toplight's 1 m integrating sphere, after 20 ms drive, Measurement tolerance:± 2



TECHNICAL DATA SHEET

ATE-R10 <FOR TOPLITE COB MODULE>

3-3. Characteristics diagram (TYP.)

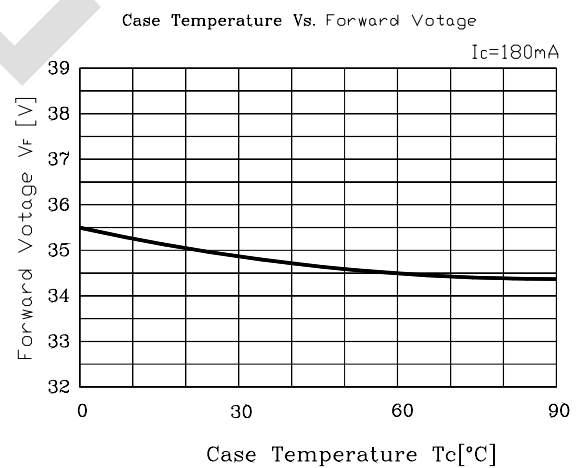
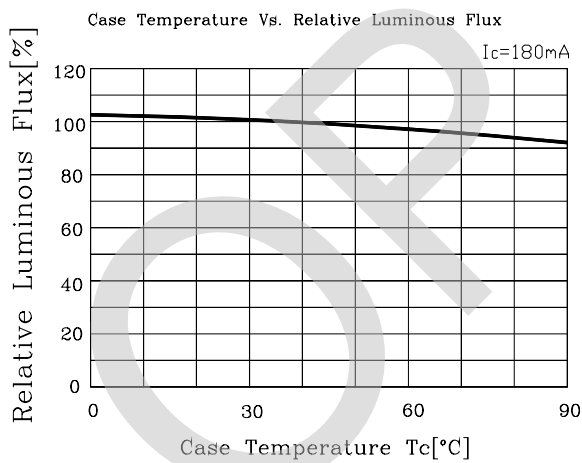
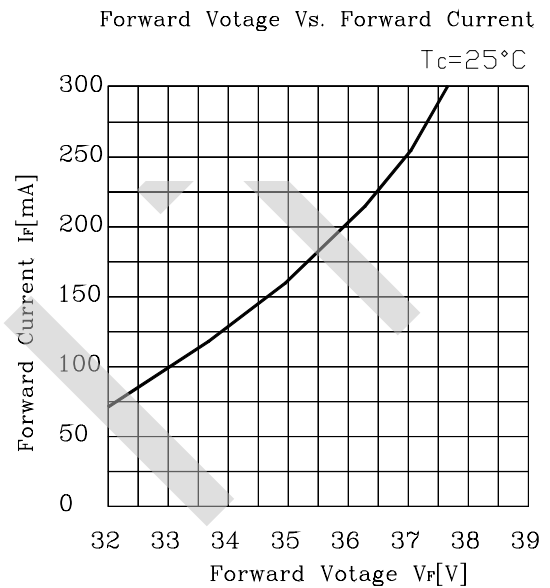
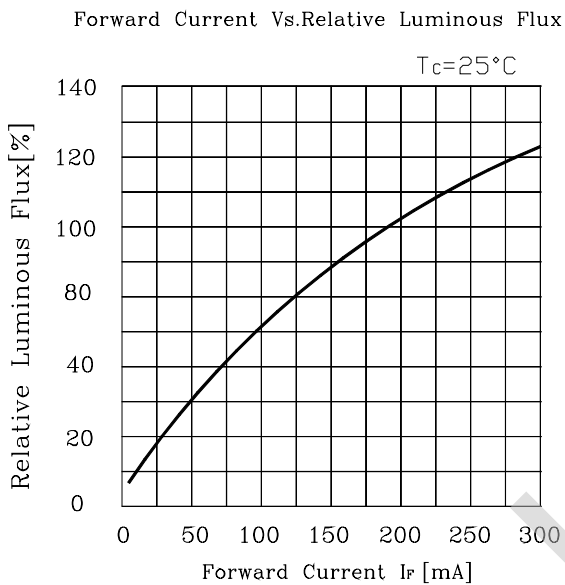

**TECHNICAL DATA SHEET****ATE-R10** <FOR TOPLITE COB MODULE>**4. RELIABILITY**

The reliability of products shall be satisfied with items listed below.

4-1. TEST ITEMS AND TEST CONDITIONS

NO.	TEST ITEM	TEST CONDITIONS	RESULT
1	Continuous operation test	$T_a = 25^\circ\text{C}$, $I_F = 180\text{ mA} \times 1000\text{ hours}$ (with Al fin)	PASS
		$T_a = 80^\circ\text{C}$, $T_j = 120^\circ\text{C}$, $I_F = 180\text{ mA} \times 1000\text{ hours}$ (with Al fin)	
2	Low temperature storage	$T_a = -40^\circ\text{C} \times 1000\text{ hours}$	PASS
3	High temperature storage	$T_a = 100^\circ\text{C} \times 1000\text{ hours}$	PASS
4	Moisture resistance	$T_a = 60^\circ\text{C}$, 90%RH for 1000 hours	PASS
5	Thermal shock	$T_a = -40^\circ\text{C} \times 30\text{ minutes} \sim 100^\circ\text{C} \times 30\text{ minutes}$, 100 cycle	PASS

4-2. FAILURE CRITERIA

NO.	PARAMETER	SYMBOL	FAILURE CRITERIA
1	Forward Voltage	V_F	$V_F > \text{Initial value} \times 1.1$
2	Luminous Flux	Φ	$\Phi < \text{Initial value} \times 0.7$



TECHNICAL DATA SHEET

ATE-R10 <FOR TOPLITE COB MODULE>

5. CHROMATICITY COORDINATES REGIONAL

5-1. 3000K CHROMATICITY COORDINATES

(Tolerance: $x,y \pm 0.005$)

($I_F = 180\text{mA}, T_c = 25^\circ\text{C}$)

Range		Chromaticity coordinates				
		NO.1	NO.2	NO.3	NO.4	CENTER
	x	0.4562	0.4299	0.4147	0.4373	0.4338
	y	0.4260	0.4165	0.3814	0.3893	0.4030

* The percentage of each rank in the shipment shall be determined by TOPLIGHT.

Chromaticity Diagram

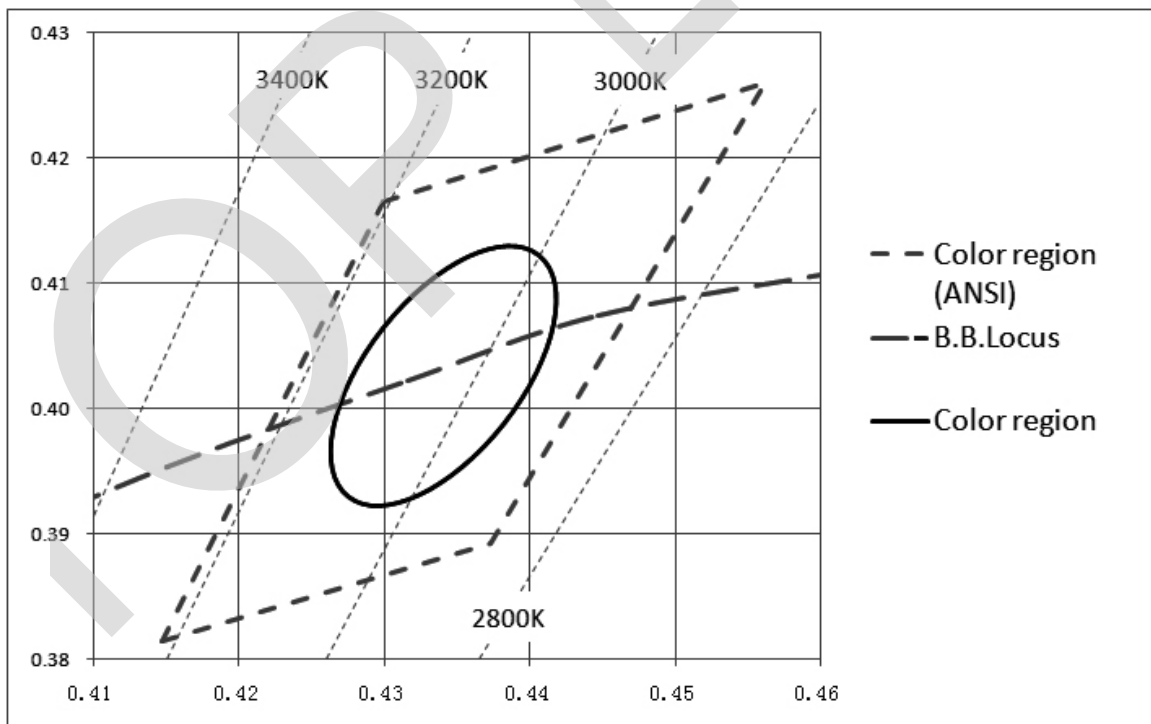

Note: The tolerance of measurement at our tester is $V_F \pm 3\%$, $D_v \pm 10\%$, $\text{Chromaticity}(x,y) \pm 0.005$.



TECHNICAL DATA SHEET

ATE-R10 <FOR TOPLITE COB MODULE>

5-2. 5000K CHROMATICITY COORDINATES

(Tolerance: $x,y \pm 0.005$)

($I_F = 180\text{mA}$, $T_c = 25^\circ\text{C}$)

Range		Chromaticity coordinates				
		NO.1	NO.2	NO.3	NO.4	CENTER
	x	0.3551	0.3376	0.3366	0.3515	0.3447
	y	0.376	0.3616	0.3369	0.3487	0.3553

* The percentage of each rank in the shipment shall be determined by TOPLIGHT.

Chromaticity Diagram

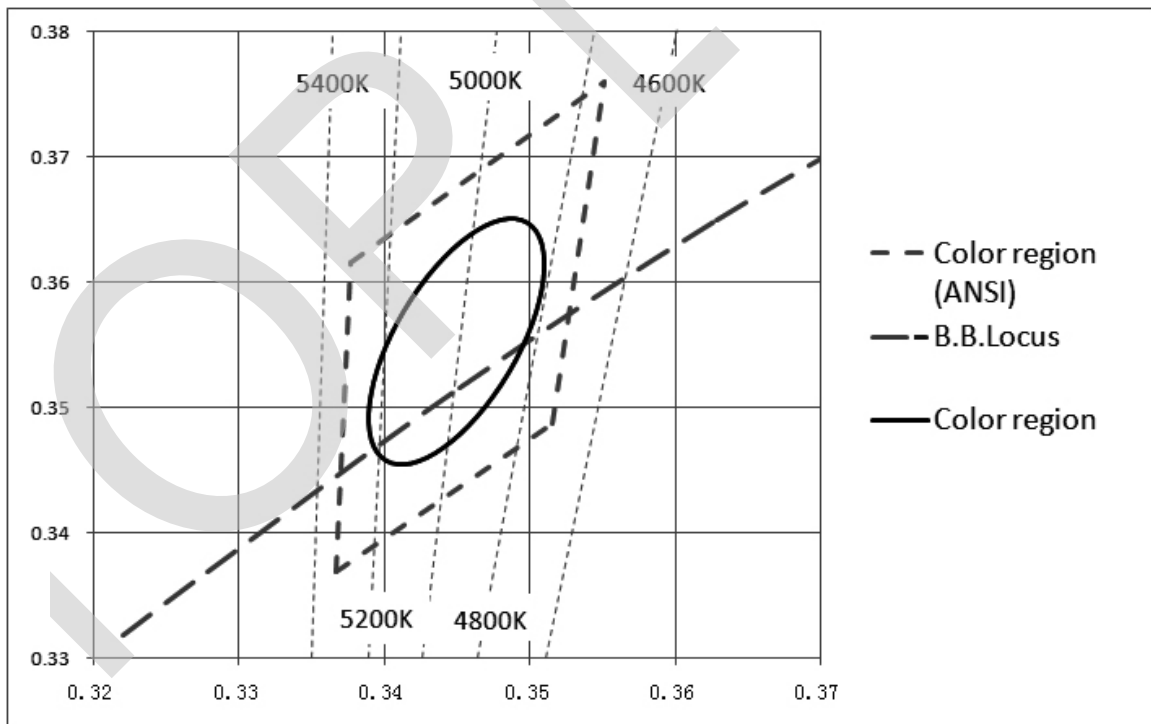

Note: The tolerance of measurement at our tester is $V_F \pm 3\%$, $D_v \pm 10\%$, Chromaticity(x,y) ± 0.005 .



TECHNICAL DATA SHEET

ATE-R10 <FOR TOPLITE COB MODULE>

5-3. 6500K CHROMATICITY COORDINATES

(Tolerance: $x,y \pm 0.005$)

($I_F = 180\text{mA}$, $T_c = 25^\circ\text{C}$)

Range		Chromaticity coordinates				
		NO.1	NO.2	NO.3	NO.4	CENTER
	x	0.3205	0.3028	0.3068	0.3221	0.3123
	y	0.3481	0.3304	0.3113	0.3261	0.3238

* The percentage of each rank in the shipment shall be determined by TOPLIGHT.

Chromaticity Diagram

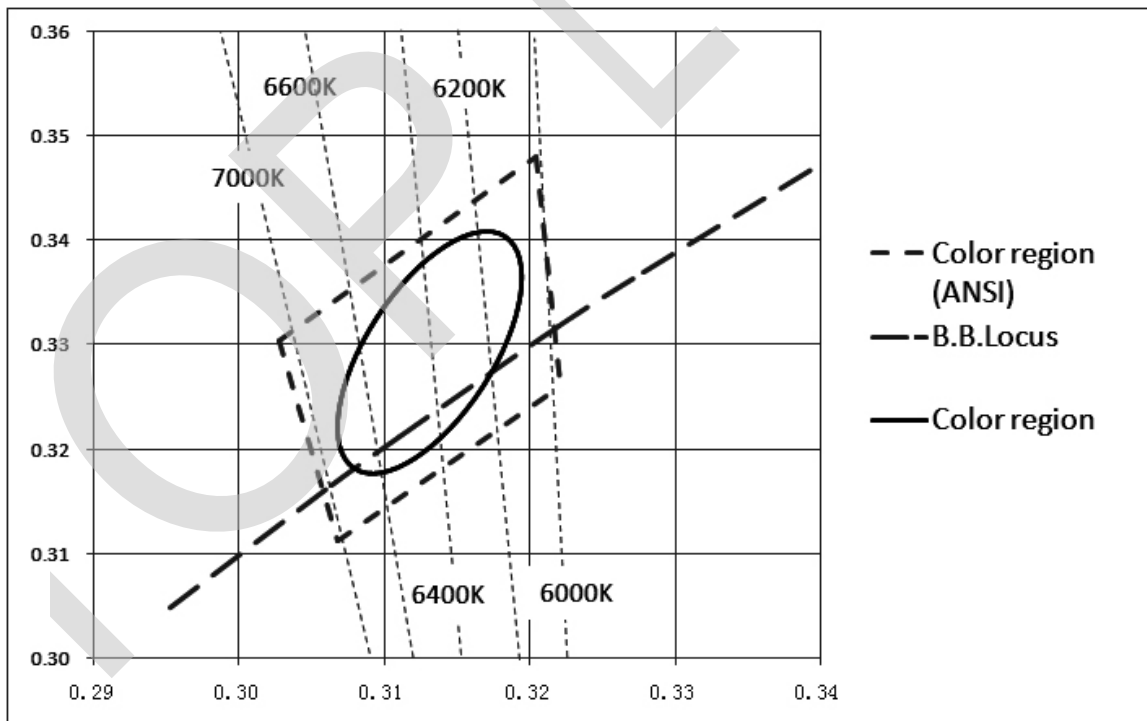

Note: The tolerance of measurement at our tester is $V_F \pm 3\%$, $D_v \pm 10\%$, Chromaticity(x,y) ± 0.005 .



TECHNICAL DATA SHEET

ATE-R10 <FOR TOPLITE COB MODULE>

9 / 9

6. USE STANDARD & PRECAUTIONS

Before use TOPLITE COB product, carefully read the specifications;

Handling with care for this product

Never touch the optical surface with finger or sharp object. The LED surface could be soiled or damaged, which could affect the optical performance of the LED.

Do not apply direct pressure on the optical surface.

Do not touch the resin with tweezers to avoid scratching or other damage.

In work environment, please keep handling the LEDs with appropriate ESD grounding. because this is a semiconductor product.

Please take adequate measures to prevent any static electricity being produced:such as the wearing of a wristband or anti-static gloves when handling this product.

